

PR5200 Series

Motor Soft starter

Operating manual



POWTRAN

Soft Starter

www.powtran.com

Foreword

Thank you very much for purchasing PR5200 soft starter.

This user's manual provides the users with the instructions on the installation, parameter setting, error diagnosis, routine maintenance and necessary precautions. Please read the manual carefully before the installation of the product in order to ensure that it can be correctly installed and operated.

Please contact Powtran's dealers or directly contact with the company if you have difficult questions during the use of the soft starter, our professional staff is willing to serve for you.

Please leave this manual to the end user and keep it in good condition for the future maintenance and other application occasions. Please fill in the warranty card then fax to the distributor or fax to Powtran if there is quality problem during the warranty period.

During this product updating period, some details may be changed without prior notice. If you want to get the latest information, please visit our website.

For other products' information, please visit our homepage:
<http://www.powtran.com>.

Powtran

Contents

Chapter 1	The introduction of PR5200 soft starter	1
1-1.	The feature of the PR5200 soft starter	1
1-2.	The main function of the PR5200 soft starter	1
1-3.	The main features of the PR5200 soft starter	1
Chapter 2	Product model description and open - package inspection	3
2-1.	Product model description	3
2-2.	The steps of open - package inspection	3
Chapter 3	The conditions of use and installation requirements	4
3-1.	The conditions of use of the soft starter	4
3-2.	The installation requirements of the soft starter	4
3-3.	The appearance and installation dimension of the soft starter	4
Chapter 4	Main circuit and terminal wiring	8
4-1.	The basic wiring diagram of the soft starter	8
4-2.	Instruction of soft starter terminal wiring	9
Chapter 5	Control panel and operation	11
5-1	Keyboard operational approach	11
5-2	Function parameters setting and description	13
5-3	Programmable relay output functions	14
5-4	Operation protection function of power on terminal	14
5-5	Other settings description	15
5-6	Help and instructions	15
Chapter 6	Protection and description	16
6-1.	Protection functions and their parameters	16
6-2.	Protection level setting description	16
Chapter 7	Test runing and application	18
7-1.	Power test running	18
7-2.	PR5200 series soft starter starting mode and application	19
7-3.	PR5200 series soft starter's stop mode and application	20
7-4.	Special application	21
7-5.	Application examples	22
Chapter 8	RS485 communication	23
8-1.	Summary of the modbus RTU communication protocol	23
8-2.	The soft starter associated settings	23
8-3.	Exception reponse	24
8-4.	Using the matters need attention	25
Chapter 9	Fault causes and treatment	26
Chapter 10	Soft-start model specifications and options	27
Chapter 11	Warranty	28

Precaution

- Thanks for selecting intelligent motor soft starter products from Powtran technology Co., LTD., we will with excellent performance in return for your attention!
- Please pay attention to the following matters during the soft starter installation, operation and maintenance process



Please be sure to read the operating instructions before installation



Must by professional technicians to install the soft starter



The specifications of the motor must match with the soft starter



Prohibit to connect the capacitors in soft starter output terminal (U, V, W)



The bare terminals must be wrapped by insulating tape after installation



Soft starter or related equipment should be reliable grounding



Input power must be cut off when equipment maintenance



Do not disassemble , modify, maintenance of this product personally.

Only trained people are allowed to operate this device, please read this manual about the safety, installation, operation, and maintenance section before use of the items. The safe application of this equipment depends on the correct transportation, installation, operation and maintenance.

Chapter 1 The introduction of PR5200 soft starter

1-1.The feature of the PR5200 soft starter

PR5200 series intelligent motor soft starter incorporates the latest motor control theory and proprietary motor protection technology and advanced software technology of new equipment, it is an ideal replacement of startup products which early used start method of “Star to Triangle conversion”, “autoformer step-down voltage” and “magnetic control step-down voltage”; at present market ,Its performance is more superior than other ordinary soft starter without using intelligent control technology.

1-2.The main function of the PR5200 soft starter

- To reduce the motor starting current and reduce power distribution capacity, avoid investment of expansion of power capacity.
- Toreduce the starting stress of the motor and the load of the equipment ; extend lifespan of the motor and related equipments.
- Its soft stop function can effectively solve the problem of parking vibration of the inertial system,which is unable to realize by traditional starting equipment.
- To have six unique start-up modes adapts to the complex conditions of motor and load, to perfect start effect.
- Has the perfect and reliable protection function; effectively protect the motor and the related production equipment use safety.
- Motor soft starter intelligence, and network technology application makes motor control technology to adapt to the rapid development of the electric power automation technology in higher requirements.

1-3.The main features of the PR5200 soft starter

- **Perfect human nature design:**
 - Beautiful shape and reasonable structure
 - Perfect function and easy operation
 - Sturdy and reliable and compact structure
 - Industrial product excellence in the design of art.
- **Reliable quality assurance:**
 - Using the computer simulation design.
 - SMT placement production process.
 - Excellent electromagnetism compatibility.
 - The whole machine of aging, vibration test in high temperature before they leave the factory
- **Perfect and reliable protection function:**
 - Voltage lose, lower voltage and over-voltage protection.
 - Soft starter motor overheating, lower load, too long starting time protection.
 - Input phase lose, output phase lose, three-phase unbalance protection.
 - Startup current, overload, short circuit protection.
- **Proprietary intellectual property products:**

- Appearance design patent.
- Independent software copyright.
- Proprietary motor starting and protection technology.
- Unique testing debugging equipment and process.
- **Swift thoughtful after-sales service:**
 - Reliable performance and quality lay the foundation of excellent service.
 - Provide excellent perfect supporting design scheme.
 - Timely and thoughtful use consultation.
 - Continuously improve product performance according to user opinion

Chapter 2 Product model description and open - package inspection

2-1.Product model description

2-1-1. Instructions on nameplate

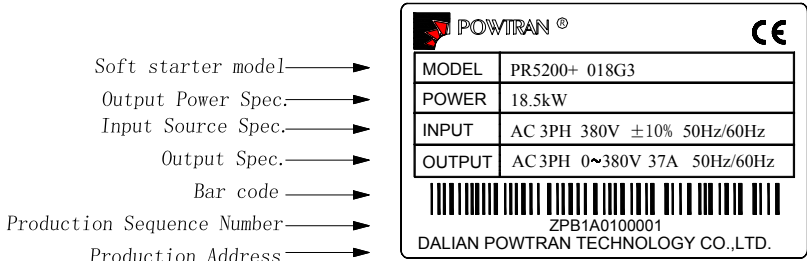

Figure 2.1

2-1-2. Model designation

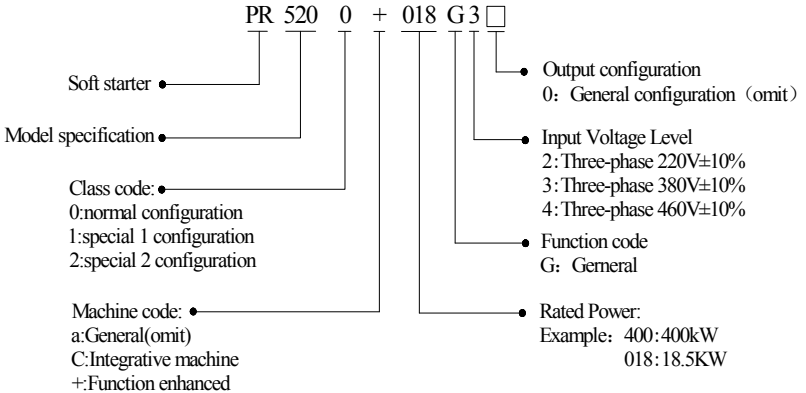

Figure 2.2

(Note: The function enhanced- software algorithm to optimize, the standard RS485 built-in)

2-2.The steps of open - package inspection

Each PR5200 series soft starter is under strict inspection and testing before they leave the factory. Users received the products and unpacked, please follow the inspection steps , if found problem, please contact the supplier promptly.

- ◆ Confirm the soft starter without any damage in transport process (machine body damage or gap).
- ◆ Check with the machine, the instruction manual,the warranty card
- ◆ Check the product of the specifications of the enclosure panels, ensure that the received goods match with you ordered products

Chapter 3 The conditions of use and installation requirements

PR5200 series soft starter should comply with the following conditions of use and installation requirements; otherwise, the performance will not guarantee, it can shorten life of soft starter even damage.

3-1. The conditions of use of the soft starter

3-1-1. Power supplies: The utility, self-power station, diesel generating sets three-phase AC 380 V plus or minus 10%, frequency 50 Hz or 60 Hz, the power supply capacity must meet soft starter motor starting to the requirement

3-1-2. Applicable motor: Mouse cage type three-phase asynchronous motor, ac motor rated power should be matching with soft starter rated power .

3-1-3. Starting times: Less than 10 times / hour. Cooling way: Air cooling.

3-1-4. The protective level: IP20.

3-1-5. Environmental conditions: Below elevation 3000 meters, the environment temperature between -25 °C ~ + 40 °C, relative humidity below 90% RH, no dewing, no inflammable, no explosive, no corrosive gas easily, have no electrical conductivity dust, indoor and ventilated good, vibration is less than 0.5 G place.

★ We can offer under special conditions of use products, such as the explosion proof type, low temperature, high pressure type soft starter, its use conditions will need further instructions.

3-2. The installation requirements of the soft starter

■ Installation direction and distance: In order to ensure that the soft starter in use with good ventilation and cooling conditions, soft starter should be installed vertically, and in the equipment with sufficient heat dissipation space all round, as shown in Figure 3.2 and Figure 3.1, in the photo, to allow the minimum distance.

■ When the soft starter is installed in the cabinet, in addition to the above requirements, the upper and lower well ventilated cabinet is selected.

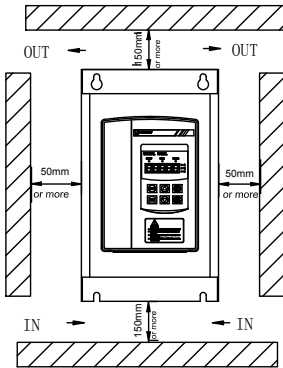

Figure 3.1

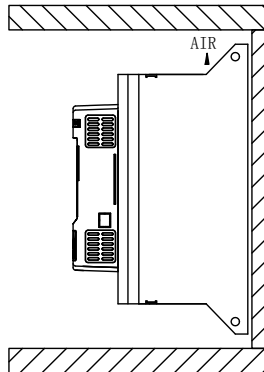

Figure 3.2

PR5200 series integrative machine, wall-mounted (without cabinet installation) and cabinet choose wall-mounted or landed installation, require surroundings ventilated, without dust and other suspended solids.

3-3. The appearance and installation dimension of the soft starter

3-3-1. PR5200 + series 5.5kw-115kw soft starter shape and installation size as shown in Figure 3.3, PR5200 + series 132kw-500kw soft starter shape and installation size as shown in Figure 3.4. The factory standard is three to six.

Rated power and rated current refer to the maximum rated value of soft starter. In general, the corresponding parameters of the adaptive motor should not exceed this value.

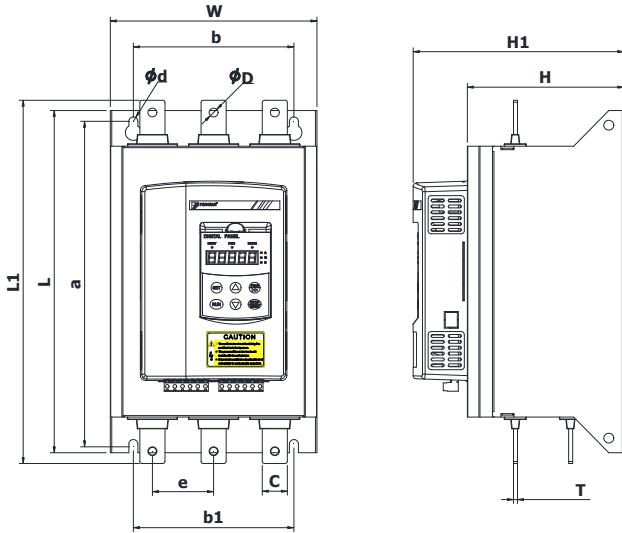

Figure 3.3

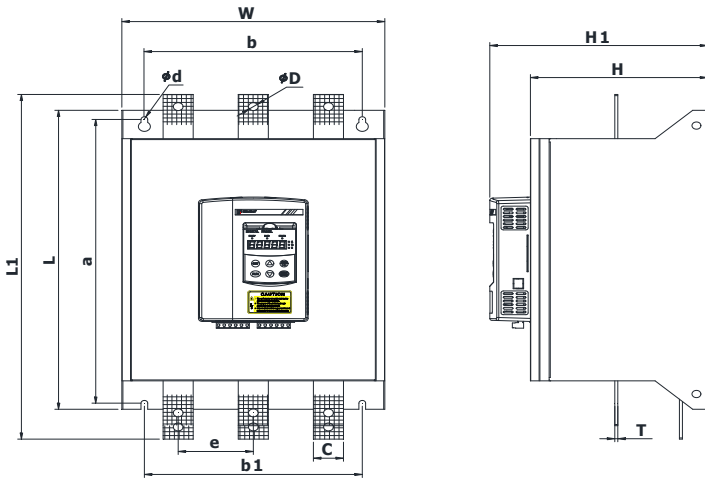

Figure 3.4

Chapter 3 The conditions of use and installation requirements

G2 series

Model	Rated Power (kw)	Rated current (A)	Base No.	Dimension(mm)					Installation(mm)					Copper bar size(mm)			Net (kg)
				L1	L	W	H1	H	a	b	b1	d	e	C	D	T	
PR5200+ 7R5G2	7.5	30	5R1	303	288	146	159	105	270	115	115	Ø8	42	15	8	3	<3.8
PR5200+ 011G2	11	45															
PR5200+ 015G2	15	60															
PR5200+ 018G2	18.5	75															
PR5200+ 022G2	22	90															
PR5200+ 030G2	30	110															
PR5200+ 037G2	37	150	5R2	372	350	206	210	156	330	160	160	Ø9	61	25	9	4	<10.2
PR5200+ 045G2	45	180															
PR5200+ 055G2	55	230															
PR5200+ 075G2	75	260	5R3	529	480	280	264	210	450	230	230	Ø9	90	40	13	4.5	<22.4
PR5200+ 090G2	90	320															
PR5200+ 115G2	115	370															
PR5200+ 132G2	132	420															
PR5200+ 160G2	160	560															
PR5200+ 185G2	185	600	5R4	558	505	326	256	202	476	260	260	Ø10	103	40	13	5.5	<28.6
PR5200+ 200G2	200	660															

G3 series

Model	Rated Power (kw)	Rated current (A)	Base No.	Dimension(mm)					Installation(mm)					Copper bar size(mm)			Net (kg)
				L1	L	W	H1	H	a	b	b1	d	e	C	D	T	
PR5200+ 5R5G3	5.5	11	5R1	303	288	146	159	105	270	115	115	Ø8	42	15	8	3	<3.8
PR5200+ 7R5G3	7.5	15															
PR5200+ 011G3	11	23															
PR5200+ 015G3	15	30															
PR5200+ 018G3	18.5	37															
PR5200+ 022G3	22	45															
PR5200+ 030G3	30	60															
PR5200+ 037G3	37	75															
PR5200+ 045G3	45	90															
PR5200+ 055G3	55	110															
PR5200+ 075G3	75	150															
PR5200+ 090G3	90	180															
PR5200+ 115G3	115	230															

Chapter 3 The conditions of use and installation requirements

PR5200+ 132G3	132	260	5R3	529	480	280	264	210	450	230	230	Ø9	90	40	13	4.5	<22.4
PR5200+ 160G3	160	320															
PR5200+ 185G3	185	370															
PR5200+ 200G3	200	400															
PR5200+ 250G3	250	500															
PR5200+ 280G3	280	560	5R4	558	505	326	256	202	476	260	260	Ø10	103	40	13	5.5	<28.6
PR5200+ 320G3	320	630															
PR5200+ 400G3	400	800															
PR5200+ 450G3	450	900															
PR5200+ 500G3	500	998															

G4 series

Model	Rated Power (kw)	Rated current (A)	Base No.	Dimension(mm)					Installation(mm)					Copper bar size(mm)			Net (kg)
				L1	L	W	H1	H	a	b	b1	d	e	C	D	T	
PR5200+ 5R5G4	5.5	11	5R1	303	288	146	159	105	270	115	115	Ø8	42	15	8	3	<3.8
PR5200+ 7R5G4	7.5	15															
PR5200+ 011G4	11	23															
PR5200+ 015G4	15	30															
PR5200+ 018G4	18.5	37															
PR5200+ 022G4	22	45															
PR5200+ 030G4	30	60															
PR5200+ 037G4	37	75															
PR5200+ 045G4	45	90															
PR5200+ 055G4	55	110															
PR5200+ 075G4	75	150															
PR5200+ 090G4	90	180															
PR5200+ 115G4	115	230															
PR5200+ 132G4	132	260	5R3	529	480	280	264	210	450	230	230	Ø9	90	40	13	4.5	<22.4
PR5200+ 160G4	160	320															
PR5200+ 185G4	185	370															
PR5200+ 200G4	200	400															
PR5200+ 250G4	250	500															
PR5200+ 280G4	280	560	5R4	558	505	326	256	202	476	260	260	Ø10	103	40	13	5.5	<28.6
PR5200+ 320G4	320	630															
PR5200+ 400G4	400	800															
PR5200+ 450G4	450	900															
PR5200+ 500G4	500	998															

Chapter 4 Main circuit and terminal wiring

- ★ PR5200 series soft starter has two kinds of wiring:
 The main circuit wiring: Three phase power input and output to the motor wiring and coil in line circuit breaker, bypass contactor wiring.
 External terminal wiring: By 14 small terminals derivation, including input, output control lines and analog output signal lines.

4-1. The basic wiring diagram of the soft starter

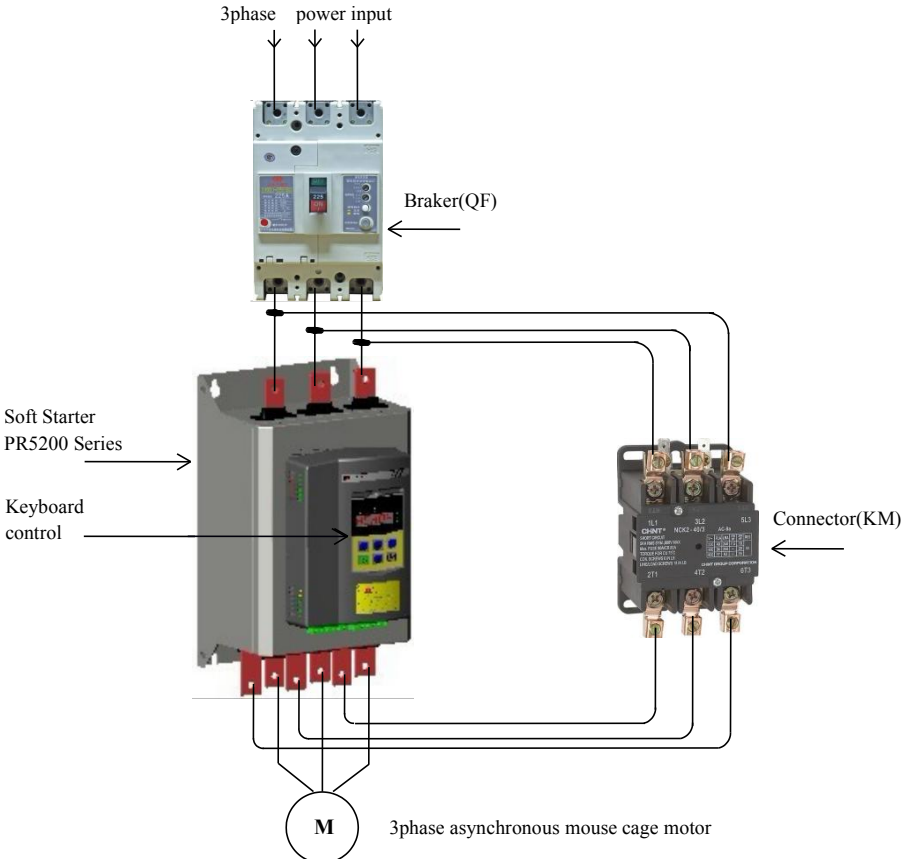

Note: six copper bar, R,S,T is connected to three-phase power supply, U,V,W is connected to motor.

Figure 4.1

4-2.Instruction of soft starter terminal wiring.

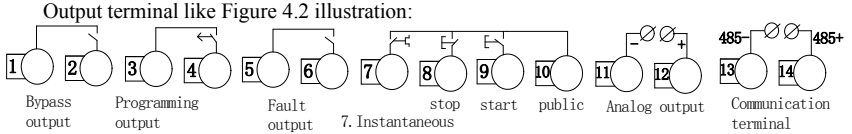

4-2-1.Terminal 1, 2 is bypass output which is used to control bypass contactor. Normally open terminal will close.The terminal capacity is AC 250V/5A.

4-2-2.Terminal 3, 4 is programmable relay output, output model and function set by “PE”parameter. This terminal is normally open passive pot. Capacity is AC 250V/5A.

4-2-3.Terminal 5, 6 is error output: Which will close when soft starter error or power lose. Capacity is AC250V/5A.

4-2-4.Terminal 7 is transient stop input. This terminal must connect with terminal 10 when soft starter normally work. If Terminal 7 disconnect with terminal 10, softstart will transient stop and show error. This terminal can be controlled by normal close output terminal of outside protection device, set PA to 0 (primary protection),this terminal function is prohibited.

4-2-5.Terminal 8, 9, 10 is for wiring of outside control start,stop button. There are two type wiring way(3 lines and 2 lines) to choose proper way according to demand. As Figure 4.3.

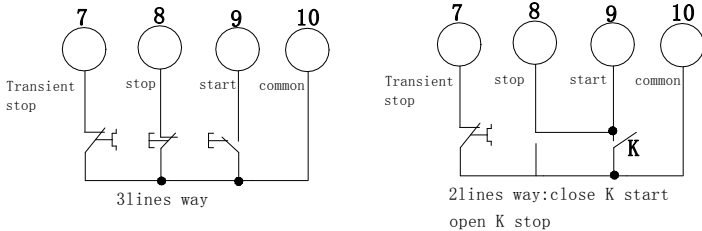

4-2-6.Terminal 11, 12 is 0~20ma, 4~20ma DC analog output. Which is used to inspect the motor current. The max 20ma indicates motor current is 4 times of soft starter rated current. Which can be viewed by extra 0~20ma, 4~20ma current meter. The max resistor of output load is 300Ω. Remark: The machine defaults to 4 ~ 20ma output, if need 0 ~ 20ma output please explain in order.

4-2-7.Terminal 13, 14 for the RS485 communication terminal, 13 for the communication terminal“485-”, 14 for the communication terminal “485+”.

4-2-8.The outside terminal should be correct connection, otherwise which will damage this softstarter.

4-2-9.PR5200series soft starter main circuit diagram.

4-2-10.

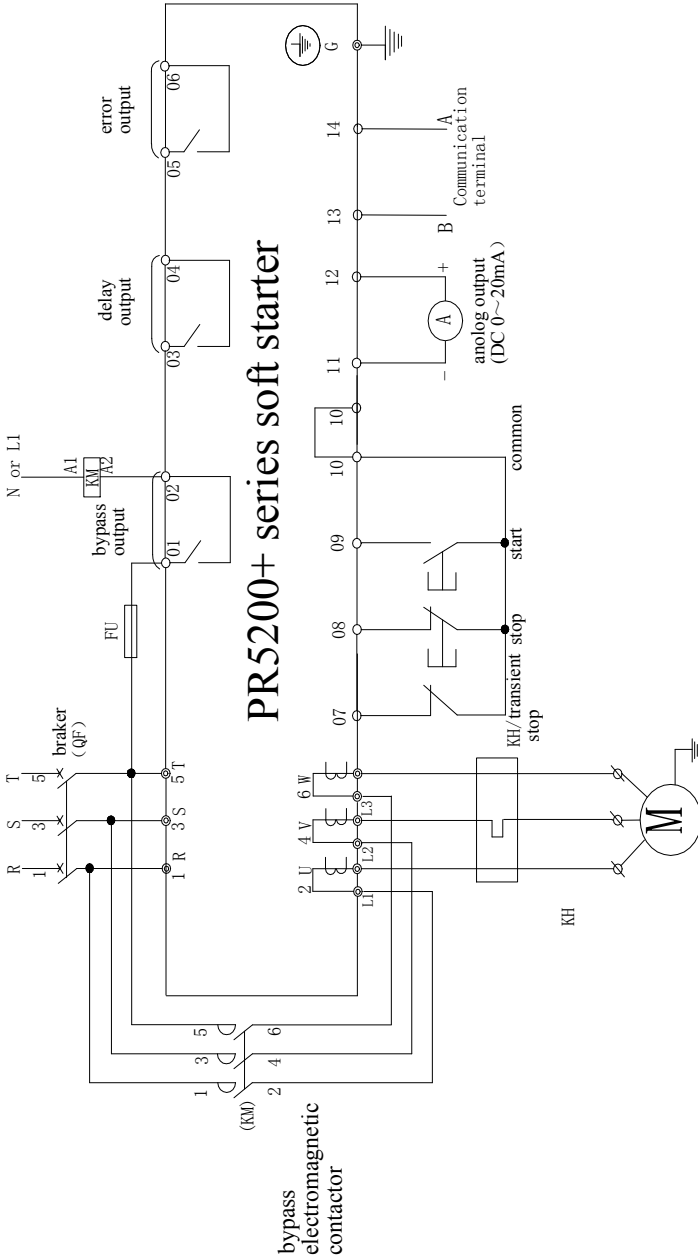

Figure 4.4

Chapter 5 Control panel and operation

★PR5200series soft starter has five kinds working state: Ready, running, error, start and stop. Ready, running, error has corresponding state light.Startup indicatesxxxx, softstop indicates — XXX ,and xxxxxindicates motor current.

5-1Keyboard operational approach

JP3E5200 keyboard diagram

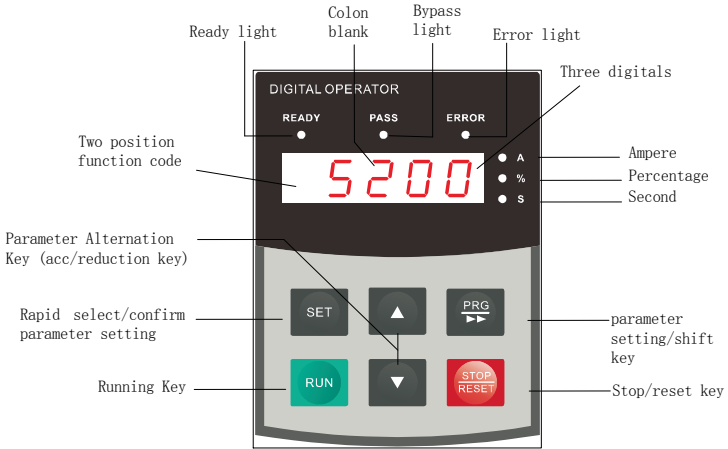

Figure 5.1

JP3E5200D keyboard diagram

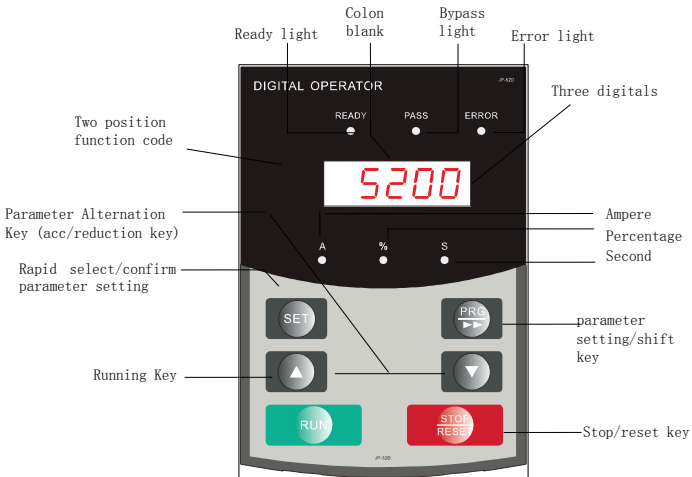

Figure 5.2

5-1-1.Startup state: When the indication ready light display 5200 or **READY**,then softstater can start. The displaying 5200 means POWTRAN 5200 series softstarter. And **READY** means ready to start.

5-1-2.Delay state: Ready or error state indication light flash means interval, display dexxx and count down means startup delay.

5-1-3.Start and stop key:In the process of soft startup,the screen display XXXX to indicates motor current, and only Stop key is valid, and can not enter menu to set parameter, and ready,running,error lights black out.In the process of soft stop, the screen displayxxxx to indicates motor current,and only RUN key is valid, and can not enter menu to set parameter, and ready, running, error lights black out, meanwhile the stop key has reset function.

5-1-4.PRg key , in the non-help mode, press the PRG key to enter the setup menu,display PX: XXX,then press PRG key again, colon flashes, that means can modify the parameters after colon.Press the Set key when the colon flashes, if the data has been modified, it will display good and twice ring, indicating that new data has been saved, and then exit. If you do not want to save the new data, press the PRG key, colon will stop flashing and restoring the original data, then press Set key or Stop key to exit.

5-1-5.Set key, in the non-setting state, press the set key to enter the help menu, display HX: XXX, press the Set key or stop key to exit. In setting state, press the set key to save the new setting of data and to exit the setting state.

5-1-6.Acceleration,deceleration key, in the setting menu, when the colon does not flash ,press the acceleration or deceleration key to change the function number; when colon flashes, press the acceleration or deceleration key to change the data, press on the acceleration or deceleration key for more than 1 second, the data will be increased or decreased continuously and quickly .In the help menu, press the acceleration or deceleration key to change the function number and the corresponding message.When the indicator light of bypass operation is on, and did not enter the setting and help menu, display AXXXX, that means the motor running current, then press the acceleration or deceleration key to select display PXXXX or HXXXX. PXXXX indicates motor apparent power;HXXXX indicates motor overloaded heat balance coefficient. When indication value of HXXXX is more than 100%,soft starter will be overload protection and display Err08.

5-1-7.When the data is more than 999, the last decimal point is bright, indicates the mantissa + 0.

5-1-8.If the key operating is effective,there will be a voice tip, or this key does not work in this state.

5-1-9.When the external control terminal connected to a 3-wire mode, the external control start button and stop button have the equivalent function with start and stop keys on the control panel.

5-1-10.The control panel with super anti-jamming design,and the outside connection distance is allow to be more than 3 m.

5-1-11.Keyboard digital display illustration

Display letter	Relative letter	Display letter	Relative letter	Display letter	Relative letter
0	0	1	1	2	2
3	3	4	4	5	5
6	6	7	7	8	8
9	9 or g	A	A or R	b	B
C	C	d	D or D	E	E
F	F	H	H	J	J
L	L	N	N	U	U or V

0	O	P	P	r	R
y	Y	AUN	RUN	UEr	Ver
rEAdy	READY	Good	Good	_Err	Err
M	M	N	N		

5-2 Function parameters setting and description

- Function parameters code in the following table

Code Setting Description				
Code	Name	Range of set value	Factory setting	Explanation
P0	Starting voltage	30-70%	40%	Voltage slope model is effective, the starting voltage of current mode is 40%.
P1	Soft starting time	2-60S	16S	Limiting current mode does not work.
P2	Soft stop time	0-60S	0S	Setting 0 means free stopping, please set 0 for one with two connections .
P3	Start interval delay	0-999S	0S	The minimum time between two successive start, the function of protecting thyristor.
P4	Language selection	0 or 1	0	0 for Chinese display, 1 for the English display.
P5	Starting current limit	50-400%	400%	The current limiting mode is effective; the maximum flow value of the voltage slope mode is 400%.
P6	Load regulation rate	50-200%	100%	Relative to the value of the rated current PP.
P7	Under voltage protection	40-90%	80%	Protection below the set value.
P8	Overvoltage protection	100-140%	120%	Protection is higher than the set value.
P9	Starting mode	0-6	1	0 limit current; 1 voltage; 2 jump; limit current; 3 jump + voltage; 4 current ramp; 5 double closed loop; 6 monitoring.
PA	Protection level	0-4	4	0 primary; 1 light load; 2 standard; 3 heavy load; 4 advanced.
PB	Control mode	0-6	1	0 keyboard; 1 keyboard + external control; 2 external control; 3 external control + communication; 4 keyboard + external control + communication; 5 keyboard + communication; 6 communication.
PC	Parameter modification allowed	0-3	1	See 5.5 other setup instructions.
PD	Correspondence address	0-64	0	For MODBUS native slave address setting.
PE	Programming output	0-19	6	See 5.3 programmable relay output functions.
PF	Soft stop current	20-100%	80%	See 7.3.1 soft stop mode.
PP	Motor rated current	11-998A	Rated value	Nominal rated current for input motor.

Chapter 5 Control panel and operation

PU	Bypass delay	0-40S	3S	Used to set bypass time delay.
PL	Three phase unbalance	0, 1	1	0 is prohibited, 1 is allowed.
PM	Current regulation rate	50-150%	100%	Used to adjust the current value of the display.
PN	Voltage regulation rate	50-150%	100%	Used to adjust the display voltage value.

Note: 1.Set the P6 load adjustment rate is calculated based on the load weight of the motor in the number of PP based on the calculation of the maximum current, more than this value will do the inverse time thermal protection.
 2.Setting the state, if more than 2 minutes without a button operation, will automatically exit the setting state.
 3.In the soft start and soft stop process can not set parameters, the other state can be set parameters.
 4.According to the confirmation key (PRG) on the power on the boot, can set parameters to restore the factory value.

5-3Programmable relay output functions

There are two programmable relay output function, programmable timing output way and programmable state output way.

5-3-1.PE set from 0 to 4 items (10 ~ 14), programmable output work is timing output way, the setting of output starting time as tabled below.

PE setting value	0(10)	1(11)	2(12)	3(13)	4(14)
Programming output time	Initiate action command	Starting at the beginning	Bypass operation	Stop action command	Stopping is complete

(1)This way of working contains a 999 seconds timer which setted by the setting item P4. If P4 is not 0, the start timing is according to the initial setting time setted by PE , when the time is up changing the output state, if P4 is 0, changing the output state immediately. The output of the reset time is to sustain 1 seconds after finishing the time delay setted by P4 and in the state of readiness.

(2)The control cycle of programmable output timing is according to one starting process, if re-start the motor , the last programming output process is automatically stopped and re-started the programming process.

5-3-2.PE is from 5 to 9 (15 ~ 19), the programmable output work is state output mode, the setting of the working state output as tabled below:

PE set value	5(15)	6(16)	7(17)	8(18)	9(19)
State of output indication	Motor fault conditions	Running	Readiness	Start state	Bypass state

(1)Programmable state output to indicate the working state of the soft starter, the time setted by P4 is invalid in this mode. The factory setting of PE is 7, which indicates the preparation state of soft starter, can start the motor in this state; programmable output is in the failure state, which indicates the fault of the motor(Err05, Err06, Err07, Err08, Err12, Err15), which is different from the function of ⑤, ⑥ fault output terminals; running state refers to non preparation or fault condition, which includes 3 process of start, bypass, soft-stop.

(2)When PE> 9, the reset state of the programmable output (③, ④ No. External pin) changed from normally open to closed, that is inverted output. Flexible using the function of programmable relay output, which can effectively simplify the external control logic circuit.

5-4Operation protection function of power on terminal

The jumper mode is selected, divided into two states.

Status 1: Power terminal operation effective protection: External control starting terminal before the power is in a closed state, soft does not respond to run the command must first run the command to remove a and run the command again after the effective soft response.

Soft fault reset time command to run effectively, soft nor the response command to run, we must first run the command removed to eliminate the operation state of protection.

Status 2: On the terminal operation protection is not valid: On the power, if the external control starting terminal is in a closed state, then the automatic starting motor, which is allowed to start on.

State 1 is shorted the 2, 3 of P5; state 2 is shorted the 1, 2 of P5. Factory default status 2.

5-5 Other settings description

5-5-1. Set item PC to modify the parameters to allow the selection of items, there are three options:

- (1) when the item PC is 0, no parameters are modified.
- (2) when the item PC is 1, the, P6, PD, PE, PP, PU, and P4 parameters are forbidden to modify the settings.
- (3) when the item PC is 2, the parameters of all settings are allowed.

5-6 Help and instructions

- Help information as following table:

Display	Explanation
AC:XXX	Three digital voltmeter, to monitor three-phase AC power supply voltage.
45A-380V	The soft starter specifications for 45A/380V.
H1:E05	Last occurred fault information Err05.
H2:E01	There had been a fault information Err01.
H3:E06	There had been a fault information Err06.
H9:E00	There was no fault information.
Uer3.0	The software version of this product is Ver3.0. With the software upgrade, version with the increase.
LXXXX	Total number of successful starting.
RUNXX	The spending time (seconds) of last soft starting (starting successfully) .
Note: H1 ~ H9 with recursive way to storage newly happened nine fault information.	

- (1) In the non-soft start and non-soft stop state, and did not enter the setting mode, press the set key, can enter the help menu, and then press the acceleration or deceleration key to select message.
- (2) In the help state, press the set key or stop button to exit help state.

Chapter 6 Protection and description

PR5200 series soft starter with complete protection to protect the safety of soft starter and motor. During the application, appropriate protection parameters and level should be setted based on different situation.

6-1. Protection functions and their parameters

6-1-1. Soft starter over-temperature protection: The temperature rose to $80\text{ }^{\circ}\text{C} \pm 5\text{ }^{\circ}\text{C}$ over-temperature protection, when the temperature dropped to $55\text{ }^{\circ}\text{C}$ (the lowest), no over-temperature protection.

6-1-2. Input phase protection lag time : <3 seconds.

6-1-3. Three-phase unbalance protection lag time: <3 seconds.

6-1-4. Three-phase unbalance protection lag time: <3 seconds. It is based on the deviation of all phase current greater than $50\% \pm 10\%$. When the load current is lower than 30% of the nominal rating of soft starter, the benchmark deviation will increase.

6-1-5. Start over current protection time: The duration is greater than the set P6 load regulation rate for the benchmark 5 times the protection time see table 6.1.

6-1-6. Running overload protection time: To set the P6 load regulation rate as the benchmark for anti time thermal protection, protective tripping time curve as shown in Figure 6.1.

6-1-7. The protection lag time of much too low supply voltage, when the power supply voltage is lower than the 40% of limit, the protection time <0.5 seconds, or the protection time <3 seconds if it is lower than the setting value.

6-1-8. The protection lag time of much too high supply voltage : When the power supply voltage is lower than the 140% of limit, the protection time <0.5 seconds, or the protection time <3 seconds if it is higher than the setting value.

6-1-9. The protection delay time of load short-circuit : <0.1 seconds, the current is 10 times more than soft starter nominal rated current. This protection can not replace fuse short-circuit protection device.

6-1-10. Motor under load protection, the current range is 10% to 90% of motor rated current, the protection action delay from 5 to 90 seconds.

These time parameters are from tested effective signal to a tripping protection instructions, and the parameters just for reference. All the protection functions of PR5200 series soft starter can be verified through the actual or simulation method. If it can't meet the user's requirements, special protection device should be added to ensure safety.

6-2. Protection level setting description

6-2-1. In order to adapt to different applications, PR5200 series soft starter has five protection level, there are 0: Primary, 1: Light load, 2: Standard 3: Heavy, 4: Advanced, it setted by PA setting. Among them,

(1) Primary protection is against to the function of external terminal instantaneous stop, meanwhile only remains the overheating, short circuit and main circuit fault protection, it can be applied to needed emergency start in unconditional occasion, such as fire systems, etc.

(2) The three protection level of light load, standard load and overload have the complete protection function. The difference is the time curves of motor overloaded thermal protection are not the same. The time parameters of motor thermal protection are as Table 6.1 and Figure 6.1.

(3) High level of protection standards is stringent at start. Other protection features parameters keep the same with standard protection set.

6-2-2. Protection level and thermal protection time according to PA setting is as the diagram below:

Table 6.1

PA setting	0 (Primary)	1 (Light load)			2 (standard)			3 (heavy load)			4 (high grade)			Description
Running overload Level of rotection	No	2 level			10 level			20 level			10 level			According to IEC60947-4-2 Standard
Start over-current Protection time	No	3 seconds			15 seconds			30 seconds			15 seconds			Starting current for more than p6setting 5times calculation
Overload trip time running list	Current multiple (I/Ie)	3	4	5	3	4	5	3	4	5	3	4	5	Typical values for the table
	Trip time (seconds)	4.5	2.3	1.5	23	12	7.5	46	23	15	23	12	7.5	

6-2-3. According to IEC60947-4-2 standard curve of the motor thermal protection tripping time is as follows:

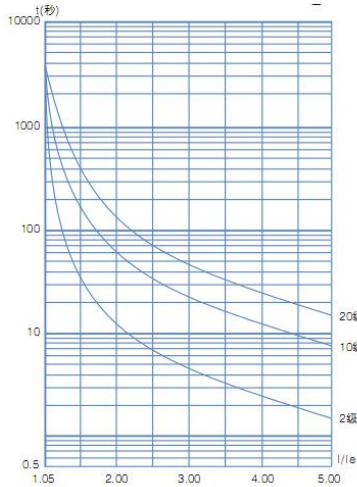

Figure 6.1

Chapter 7 Test running and application

- ★ Double-check before power running according to the following terms:
Whether the soft starter power match with the motor rated power.
Whether the motor insulation satisfy the requirements.
Whether the Input and output main circuit wiring is correct.
Whether all the terminal screws are tightened.

7-1.Power test running

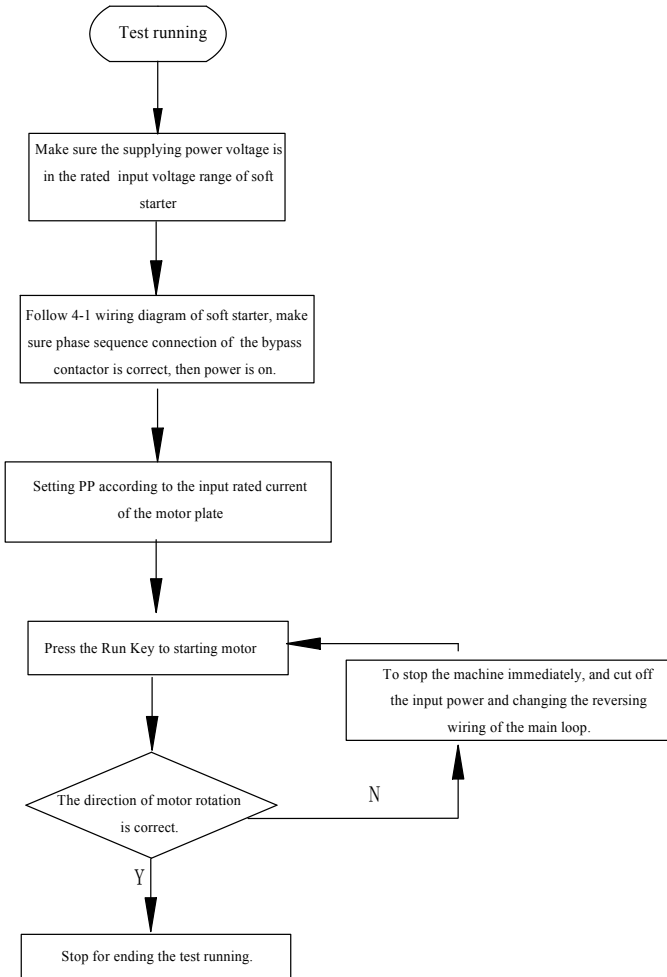

Figure 7.1

7-1-1. If the motor starter status is not satisfactory, refer to 7.2 of the soft starter starting

mode and application to select appropriate starting model.

7-1-2. If the motor starting torque is not enough, you can change the starting voltage (voltage mode) or current-limiting value (current mode), to improve the motor starting torque.

7-1-3. When soft starter power on, do not open the cover, to avoid electric shock.

7-1-4. In the power test of running, if appearing unusual phenomena, such as abnormal noise, smoke or odor, etc., should be quickly cut off the power and make further investigation.

7-1-5. If power on or when starting, appearing failure light and display errxx, you can find the reason according to the displayed fault code and the corresponding chapter of the cause. Press the stop button or external stop button to reset the fault status.

★ Note:

1). When the ambient temperature is below $-10\text{ }^{\circ}\text{C}$, should power on for more than 30 minutes to warm-up before starting.

2). When the soft starter drive the motor successfully, the operation status indicator on the middle panel lights, that proves the bypass is in running status. If at this time, the motor stop by bypass contactor without actuation, you should check the bypass contactor and associated wiring connection.

7-2.PR5200 series soft starter starting mode and application

PR5200 series soft starter has Seven models to suit a variety of complex starter motor and load conditions, the user can choose it as different application.

7-2-1 Current limit starting mode

When setting PB to 0, set the start mode for this mode.

Figure 7.2 shows the current limit mode of the motor starting current waveform changes. I_1 is starting current limit by setting, when the motor starts, the output voltage rapidly increases, till the motor current reaches the current limit value I_1 , and maintain the motor current is not higher than this value, then gradually as the output voltage increased, gradually accelerate the motor, when the motor reaches the rated speed, the bypass contactor make actuation, output current rapidly dropped to or below the motor rated current I_e , starting process is complete.

When the motor is lightly loaded or setting the current limit highly, the maximum starting current may not reach the set limit value is normal. Figure 7.2

Current limit starting mode is generally used for a strictly limited starting current requirements of the occasion.

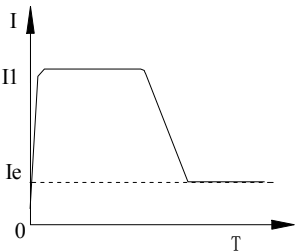

7-2-2 Voltage ramp start model

When P9 setting item is 1, start mode is for this mode.

Figure 7.3 shows the output voltage waveform as voltage ramp start voltage waveform. U_1 is the initial starting voltage of starting, when the motor start, the motor current does not exceed 400% of rated range, the output voltage of soft starter quickly rise to U_1 , then the output voltage gradually increase by the start parameters setting, the motor is in smooth acceleration according to voltage continuously rise, when the voltage reach the rated voltage U_e , the rated motor speed, bypass contactor act, starting process is complete. Figure 7.3

Starting time t is based on standard load obtained in the standard experimental conditions, control parameters, PR5200 series soft starter is based on this parameter benchmark, by controlling the output voltage, make the motor speed up in a smooth start-up process, not a mechanical control, regardless of time t . Acceleration is smooth. In view of this, when the load is light, set the start time often less than the starting time, as long as a smooth start is normal.

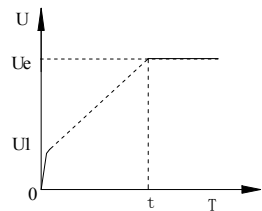

In general, the voltage ramp start mode is suit to not strict starting current requirement and strict demanding of a smooth start of the occasion.

7-2-3 Kickstart mode

P9 setting item set to 2 or 3, starter model is for this mode.

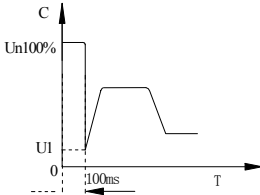

Figure 7.4

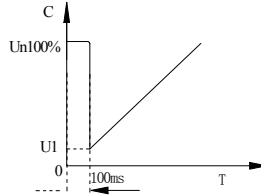

Figure 7.5

Figure 7.4 and Figure 7.5 shows the kickstart mode waveform of the output. In some heavy load situations, due to mechanical effects of static friction, when it can not start the motor, you can use this start mode. At the start, imposing a high fixed voltage to the motor first and last for a limited period of time, to

Before using this model, start motor with non-sudden jump model, if the motor can not move due to static friction, then use this model; otherwise avoid to start this mode to reduce the unnecessary high current impact.

7-2-4 Current ramp start mode

P9 items set 4, start mode is for this mode.

Figure 7.6 shows the current ramp start mode output current waveform, which I1 is the current limit set P6, T1 value is the time set by P1.

Current ramp start mode has a strong acceleration ability, for bipolar motors, can also shorten the start-up time within a certain range. Figure 7.6

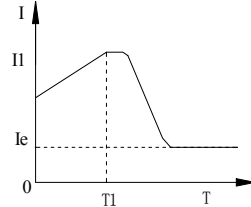

7-2-5 The voltage limiting double loop start mode

Set P9 as 5 to set start mode for this mode.

Double loop starting voltage limiting mode adopt voltage ramp and current limit dual closed-loop control model, is both stable requires and strict current limiting demanding, the integrated starter-limiting mode, it uses the prediction algorithm to estimate the work status of the motor.

In this start mode, output voltage waveform will be based on the motor and load conditions vary.

7-2-6 Monitor start mode

Started in this mode will run in direct starting, can monitor the operation of the motor current and other parameters, when running overload, overvoltage or undervoltage, fault output 5,6 terminal to cut output, also shows the corresponding fault information.

7-3. PR5200 series soft starter's stop mode and application

PR5200 series soft starters, there are two stop modes, soft-stop mode and free stop mode.

7-3-1 Soft stop mode

When Setting item P2 is not zero, set the stop mode for this mode.

In this stop mode, the motor power start from the bypass contactor and switch to the output of soft starter thyristor, soft starter output voltage decrease steadily from the total pressure, reducing the motor speed steady in order to avoid mechanical shock, till the motor stops running. Soft stop output cut-off voltage equal to the initial voltage of starting.

Soft stop mode can reduce and eliminate the surge of pump type load.

Soft stop mode can use setting item PF to set the soft stop current limit, in soft stop, reduce

the impact of high current, pay attention that, this soft start current limit is a percentage calculated on the basis of starting current limit value.

7-3-2 Free stop mode

Item P2 is set to 0, set stop mode for this mode.

In this stop mode, when the soft starter receive the stop command, immediately disconnect the bypass contactor and ban soft starter thyristors voltage output, motor gradually stop as load inertia. In the situation of one drive two(more) wiring, should set soft starter stop mode as this, in order to avoid of the phase fault reporting when output switching.

Under normal circumstances, if not necessary soft stop, stop mode should be free stop model, to extend the life of the soft starter.

As stop model completely ban the instantaneous output, can avoid an instantaneous high-current impact in special applications.

7-4.Special application

7-4-1.Motors in parallel Start:

If not exceed the rated power limit of the soft starter, the motor can be connected in parallel (motors sum current can not exceed the power of soft starter, the type selected depending on the application rated current), but at this time should provide additional thermal protection devices for each motor.

7-4-2.Two-speed motor start:

PR5200 series soft starter can start with two-speed motor, before changing from low speed to high speed, must be solved by delayed magnetic period, to avoid a very large reverse current between the line and the motor.

7-4-3.Long cable:

As the resistance of the cable causes, a very long motor cables could cause voltage landing, if the voltage drop is very obvious, it will affect the current consumption and starting torque, when choosing motor and soft starter, must consider this.

7-4-4.Soft starters paralleled with the same one power line:

If in a power line, installed several soft starters, should install the input reactor between the wiring of the soft starter and transformer, to the middle of the line should be . Reactor should be installed between each feeder circuit breaker and soft starter.

7-4-5.Surge protection Device (SPD) application:

In the applications which may suffer from lightning or other causes that lead to overvoltage, overcurrent, surge interference, should consider installing a surge protector, detailed application methods instructions, refer to POWTRAN company "surge protector (SPD)" Product sample or other relevant data.

7-5.Application examples

Under different load conditions, parameter settings for example shown in table 7.1. Data in the table is only for reference, should be adjusted according to actual situation

Table 7.1

Type of load	Start time (seconds)	The initial voltage	Voltage starting (maximum current limit)	Limit Start
Ball	30	60%	4	4.5
Fans	26	30%	4	3.5
Centrifugal pump	16	40%	4	2.5
Piston compressor	16	40%	4	3
Enhance the mechanical	16	60%	4	3.5
Mixer	16	50%	4	3
Crusher	16	50%	4	3.5
Screw compressor	16	40%	4	3
Screw conveyer	20	40%	4	2
Light load motor	16	30%	4	3
Belt conveyors	20	40%	4	2.5
Heat pump	16	40%	4	3

Chapter 8 RS485 communication

Powtran PR5200 series soft starter with built-in RS485 standard interface which can be communicated with the PC and PLC host .

It can be controlled by the host command of soft starter run/stop, monitoring the running state of soft starter and modify its function data, and so on.

8-1.Summary of the modbus RTU communication protocol

Modbus is a kind of serial asynchronous communication protocol. The physical interface RS485.Modbus is designed to modicon PLC, has the structure characteristic of PLC. Modbus in network control, the soft starter can be compared to a PLC to read and write on it. Start-stop control and status information (current, fault, etc.) And the function parameter mapping to keep register area

8-1-1.Communication parameters

Baud rate:9600; 8 Data bits; No parity bit; 1 stop bit.

8-1-2.Communication data format

The data format:

Address code	Function code	Data area	CRC check
1 byte	1 byte	N byte	2 byte

8-2.The soft starter associated settings

8-2-1.Register address

Register address	Operation code	Register function description
0001	06	Control word
0002	03	Status word
0003	03	The average current
0004	03	Fault code
0256-0274	03&06	Soft starter function code

Register is not listed above is illegal, cannot read and write, otherwise it will report to the controller an exceptional code from the station.

8-2-2.Support code

Soft start only supports the following code, if you use other code, will give exceptions to the code.

Code	03	06
Function description	Read the register	Write a single register

Code 03 only WORD (WORD) to read.

8-2-3.The register description

0001 The command register

Digit	Value	Description
0	1	Starter starting
	0	Keep the mold
1	1	Starter stop
	0	Keep the mold

Chapter 8 RS485 communication

2	0-1	To reset the starter
3-15	0	Unused

Example: Starting from the soft starter of standing 02, the controller sends 02 06 00 01 00 01, such as command execution, normal return 02 06 00 01 00 01. Starter can normal starting to view the status register, if there is a failure, should send 02 06 00 01 00 04 to reset

0002 Status register

Digit	Value	Description
0	1	Starting state
	0	Stop state
1	1	Running state
	0	Stop state
2	1	Soft stop state
	0	Stop state
3	1	Failure state
	0	The normal state
4-15		Unused

For example: Read the status register code, send 02 03 00 02 00 01, if the starter is starting to return to the 02 03 02 00 01. If the starter fails, it returns 02 03 02 00 08.

0003 current average (sixteen decimal)

The average *10 value of the value to the actual current of motor phase (including a decimal).

For example: Read the current size, send 02 03 00 03 00 01, if the current 235A, then return 02 03 02 09 2E (return value /10 for actual current value).

0004 fault code (sixteen hex)

When the state register0002 3 to 1, on behalf of the soft starter in fault state.

For example: Send 02 03 00 04 00 01, if returned 02 03 02 00 04, explain the current input missing phase (fault code 04).

Function parameter register 0XXX 5200 soft starter

0256-0274 for the function register, corresponding to the address is 0x0100-0x0112, the high byte address is 01, the status byte address is 0x00-0x12, corresponding to the function code P0-PL. For example, address P9 and function code 0x109 (starting mode). Can read and write the code.

The following examples illustrate their usage:

Example 1: Read the size of the function code P1, send 02 03 01 01 00 01.

Example 2: Read the function code PA (protection level), send 02 03 01 0A 00 01, if return 02 03 02 00 03, the reading of the protection level is 3.

Example 3: Soft starter will rewrite the function code P7 70%, send 02 03 01 07 00 01.

8-3.Exception reponse

Code	Name	Description
01	Illegal function	Unable to perform function code, the soft starter is not supported
02	Illegal data address	The received data address cannot execute, overflow
03	Illegal data values	Received data cannot execute 1. The parameters beyond the limit 2. Parameters cannot be modified 3.The runtime parameters cannot be modified

8-3-1. Illegal function code 01

The main inquiry message format:

Sub station address	Function code	Start address low byte	Start address low byte	Register number high	Register number low	CRC check
0x01	0x08	0x00	0x80	0x00	0x0d	

This agreement is not used 0 x08 function code, so the subordinate standing response:

Sub station address	Function code	Abnormal code	CRC check
0x01	0x88	0x01	

8-3-2. Illegal data address 02

Master query message format:

Sub station address	Function code	Start address low byte	Start address low byte	Register number high	Register number low	CRC check
0x01	0x04	0x01	0x80	0x00	0x07	

5200 04 function code register address error, so the sub station response:

Sub station address	Function code	Abnormal code	CRC check
0x01	0x84	0x02	

8-3-3. Illegal data values 03

The main inquiry message format:

Sub station address	Function code	Start address low byte	Start address low byte	Register number high	Register number low	CRC check
0x01	0x04	0x00	0x80	0x01	0x80	

Function code register address errors, so the child standing response:

Sub station address	Function code	Abnormal code	CRC check
0x01	0x84	0x03	

8-4. Using the matters need attention

1. Soft start device address, communication rate, calibration model must be the same with the controller communication Settings.
2. If not receive response data, should check the above parameters, to 485 terminal connection is correct, check CRC is correct or not.
3. When several soft starter communicate, should add 120 ohm resistor in the last soft starter's "485+" and "485-" terminal.
4. The P5, P6, PL, PM and PN can't read and write operations through communication.

Chapter 9 Fault causes and treatment

Fault codes and treatment as following table:

Display	Description	Problems and treatment methods
Err00	Failure has been solved	Just happened undervoltage, overvoltage or overheating, instantaneous stop terminals are open, such failures, now has been normal, this time to prepare lights, reset to start the motor.
Err01	External terminal momentary Open circuit	Short-circuit connection with the external Instantaneous stop terminal⑦and public terminal⑩, or connecting to other protective devices normally closed contact.
Err02	Soft starter overheating	Start too often or the motor power do not match with the soft starter.
Err03	Starting times too longer than 60 seconds	Starting parameter settings is inadequate or the load is too heavy, the power capacity is not enough, etc.
Err04	Input phase lost	Check the input or main circuit failure, whether the bypass contactor is stuck in the closed position and whether the SCR is in open circuit and so on.
Err05	Output phase lost	Check the input or main circuit failure, whether the bypass contactor is stuck in the closed position and whether the SCR is in open circuit and so on.
Err06	Three-phase unbalanced	Check whther the input three-phase power supply and the load motor is normal.
Err07	Start over-current	Whether the load is too heavy or motor power does not match with soft starter.
Err08	Running overload protection	Whether the load is too heavy or setting items P6, PP parameters set incorrectly.
Err09	Supply voltage is too low	Check the input voltage or setting item P7 parameter set incorrectly.
Err10	Supply voltage is too high	Check the input voltage or setting item P8 parameter set incorrectly.
Err11	Set the parameters error	Modify the settings, or pressing the Enter key on power to restore the factory values.
Err12	Load short-circuit	Check whether overloading or thyristor short circuit.
Err14	External stop terminal wiring error	When you allow external control mode, the external control stop terminal is in the open state, which can not start the motor.

Note: Some fault phenomena are interrelated, as the report Err02, may be related with soft starter overheating or load short current, so when checking fails, consideration should be comprehensive, accurately determine the point of failure.

Chapter 10 Soft-start model specifications and options

PR5200 series soft starter (5.5KW-500KW) list of the external parts of the specification reference:

Soft starter model	Rated Power (KW)	Rated current (A)	Matching circuit breaker model (QF)	Auxiliary type of bypass contactor model (KM)	A line size	Remarks
PR5200+ 5R5G3	5.5	11	16A	25A	2.5mm ² Cable	Rated power and rated current is the maximum rating of the soft starter, matching circuit breaker and the bypass contactor should match the size of motor specification.
PR5200+ 7R5G3	7.5	15	20A	25A	4mm ² Cable	
PR5200+ 011G3	11	23	32A	40A	6mm ² Cable	
PR5200+ 015G3	15	30	40A	63A	10mm ² Cable	
PR5200+ 018G3	18.5	37	50A	63A	10mm ² Cable	
PR5200+ 022G3	22	45	63A	63A	16mm ² Cable	
PR5200+ 030G3	30	60	80A	100A	25mm ² Cable	
PR5200+ 037G3	37	75	100A	160A	35mm ² Cable	
PR5200+ 045G3	45	90	125A	160A	35mm ² Cable	
PR5200+ 055G3	55	110	160A	160A	35mm ² Cable	
PR5200+ 075G3	75	150	180A	250A	25*4mm ² Copper bar	
PR5200+ 090G3	90	180	225A	250A	25*4mm ² Copper bar	
PR5200+ 115G3	115	230	315A	400A	25*4mm ² Copper bar	
PR5200+ 132G3	132	260	315A	400A	40*4mm ² Copper bar	
PR5200+ 160G3	160	320	350A	630A	40*4mm ² Copper bar	
PR5200+ 185G3	185	370	400A	630A	40*4mm ² Copper bar	
PR5200+ 200G3	200	400	500A	630A	40*4mm ² Copper bar	
PR5200+ 250G3	250	500	630A	800A	40*5mm ² Copper bar	
PR5200+ 280G3	280	560	630A	1000A	40*5mm ² Copper bar	
PR5200+ 320G3	320	630	800A	1000A	40*5mm ² Copper bar	
PR5200+ 400G3	400	800	1000A	1000A	50*8mm ² Copper bar	
PR5200+ 450G3	450	900	1600A	1250A	50*8mm ² Copper bar	
PR5200+ 500G3	500	998	1600A	1250A	50*8mm ² Copper bar	

Chapter 11 Warranty

The product quality shall comply with the following provisions (overseas market):

1. Warranty terms

1-1. The product from the ex-factory date, the warranty period of 18 months(except non-standard products), It is based on factory records.

1-2. The product from the ex-factory date. If the product appear quality problem within the normal operating range. We provide free warranty under 18 months.

1-3. The product from the ex-factory date, enjoy lifelong compensable service.

If there is a contract, we will according to the priority principle of the contract.

2. Exceptions clause

If belongs to the quality problems caused by following reasons products, we provide compensable service even though under the warranty. We will charge a maintenance fee.

2-1. The user is not in accordance with the "products manual" is used method of operation

Caused the failure.

2-2. Users without permission to alteration or repair caused by product failure.

2-3. Users beyond the standard specifications require the use of the inverter caused by Product failure.

2-4. Users to buy and then fell loss or damage caused by improper handling.

2-5. Because the user use adverse environment (such as: Humid environment, Acid and alkaline corrosion gas and so on) lead to product failure.

2-6. Due to the fault cause of earthquake, fire, lightning, wind or water disaster, abnormal

Voltage irresistible natural disasters.

2-7. Damaged during shipping ,but users are not rejected goods.

3. The following conditions, manufacturers have the right not to be warranty.

3-1. No product nameplate or product nameplate blurred beyond recognition.

3-2. Not according to the purchase contract agreement to pay the money.

3-3. For installation, wiring, operation, maintenance and other users can not describe the objective reality to the company's technical service center.

4. About the repair fee, according to our company latest price list as a standard.

5. When the products is broken, please complete the form and warranty card, shipping with the failure machine to our company.

6. Dalian Powtran Technology Co.,Ltd reserve the right to explain the terms of the event.

Product information feedback

Dear users:

Thank you for your attention and purchasing Powtran technology products! In order to serve you better, we hope to get your personal general information about using Powtran technology products, your now and future demand on POWTRAN technology products, gain for your valuable feedback. To facilitate as early as possible when you need our services, please visit the company website Powtran technology <http://www.powtran.com>"technologies and services" and "Downloads" Chapter for information feedback.

- 1) Download and update you product manual
- 2) Access to products, technical information, such as instructions, size characteristics, and frequently asked questions
- 3) Application Case Share.
- 4) Technical consulting, on-line feedback
- 5) Feedback by the form of e-mail on product information and user needs information
- 6) For the latest products, access to all kinds of additional services and extended warranty.

A manufacturer of motor control intelligent products and devices based on motor design.

☎ 400-0411-755

PR5200 English Manual V8.3

